

**Thermo Scientific  
ELEMENT 2 & ELEMENT XR**

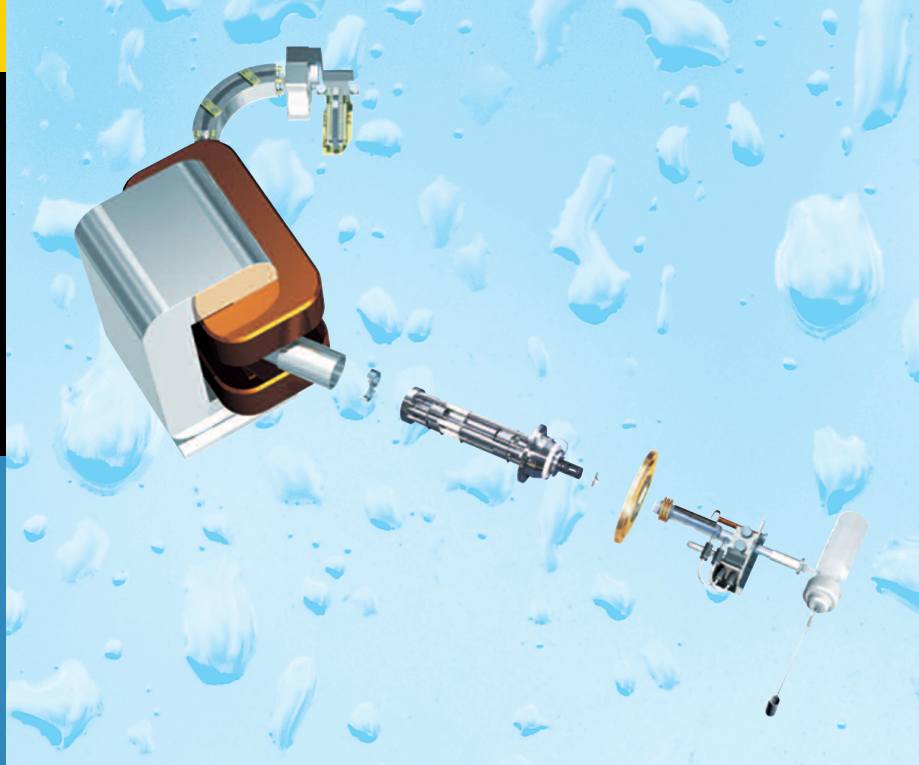

*High Performance  
High Resolution ICP-MS*

## Thermo Scientific ELEMENT 2/XR

High Performance High Resolution ICP-MS

### An Instrument for every Application

A success story around the world with over 500 instruments installed, for example:



**Belgium:** OCAS.

Research centre for the application of steel with New Wave laser ablation system.

[www.ocas.be](http://www.ocas.be)



**Sweden:** ALS Scandinavia AB.

Scandinavia's leading contract lab with Emma Engström.

[www.analytica.se](http://www.analytica.se)



**Canada:** Seastar Chemicals Inc.

A manufacturer of high purity chemicals with Dr. Brad McKelvey.

[www.seastarchemicals.com](http://www.seastarchemicals.com)



**USA:** Micron Technology Inc.

Advanced semiconductor solutions with Kevin Coyle.

[www.micron.com](http://www.micron.com)

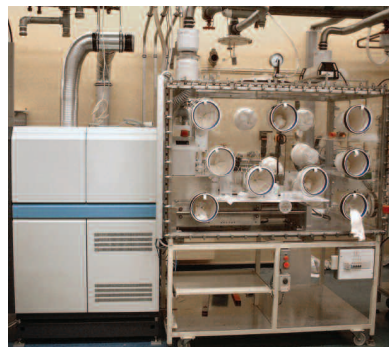

**Germany:** Institute for Transuranium Elements.

Shown with a glovebox for radioactive sample measurements.

<http://itu.jrc.ec.europa.eu/>



**USA:** Desert Research Institute.

Hydrologic Sciences Division with Steve Lambert.

[www.dri.edu](http://www.dri.edu)

- Multielement analysis across the periodic table covering a mg/L to sub pg/L concentration range
  - *Compatible with inorganic and organic solution matrices and solids*
- High mass resolution to access spectrally interfered isotopes
  - *Produces unambiguous elemental spectra*
- A multielemental detector for transient signals
  - *For example, CE, HPLC, GC, FFF and laser ablation*
- High precision isotope ratios
  - *Independent of interferences or interfered isotopes*
- Fully automated tuning and analysis
  - *In conjunction with a comprehensive, customizable quality control system*
- Reliability and robustness to serve as a 24 / 7 production control tool
  - *Highest sample throughput*
- Highest flexibility and accessibility to serve as an advanced research tool



## High Mass Resolution

The unequivocal separation of analyte ions from spectral interferences is a prerequisite of accurate and precise analysis. High mass resolution is the universal means for this separation.

Spectral interferences are the main limitation of ICP-MS. The argon plasma gas, water, acid and the sample matrix itself can combine to introduce a wide range of polyatomic ion species. The resultant interfering species may have the same nominal mass as an analyte ion and thus return a falsely high value for the analyte. Numerous strategies have been used in order to try to minimize or circumvent the formation of these spectral interferences. These include mathematical corrections, special sample introduction systems, special plasma parameters and collision/dynamic reaction cells to neutralize part of the interferences. High resolution with a sector-field mass spectrometer simply distinguishes the analyte from interference by difference in mass.

The capability of high mass resolution is a feature unique to the ELEMENT 2/XR product lines. This ability can be used for quantification and isotope ratio analysis for nearly the whole periodic table, and in almost all matrices.

**Even in a sample matrix as simple as ultra pure water (UPW), interferences do exist especially at low analyte concentration levels:**

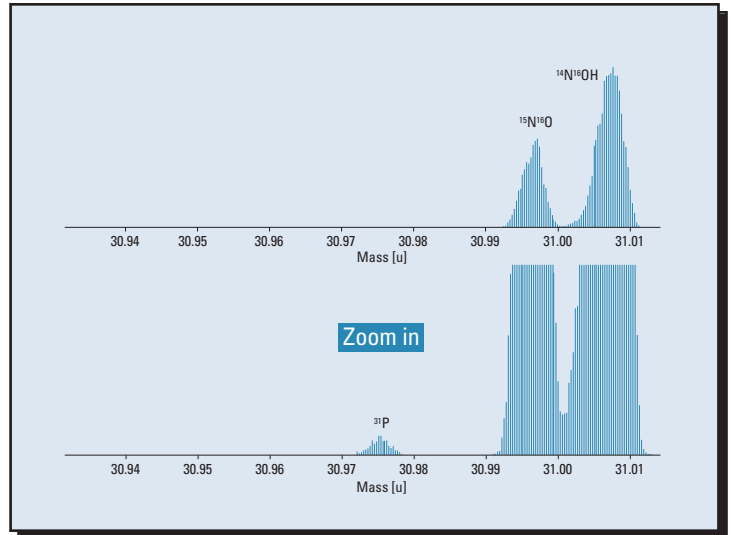

Phosphorus in UPW, Medium Resolution

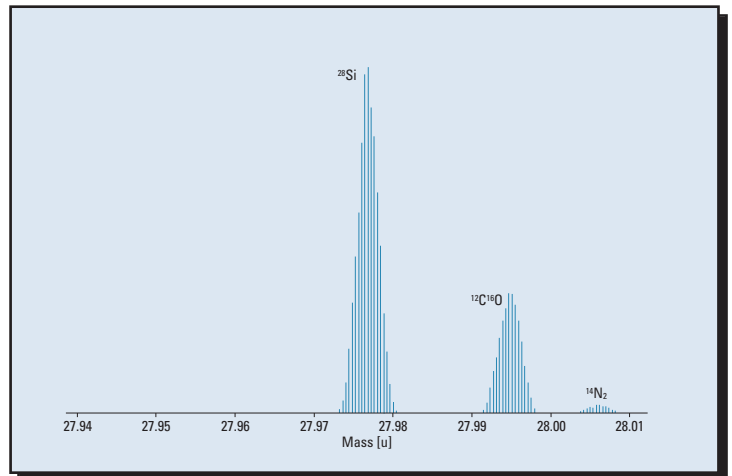

Silicon in UPW, Medium Resolution

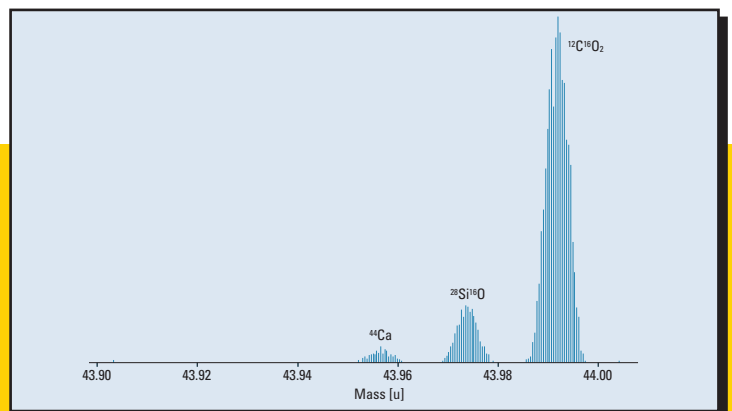

Calcium in UPW, Medium Resolution

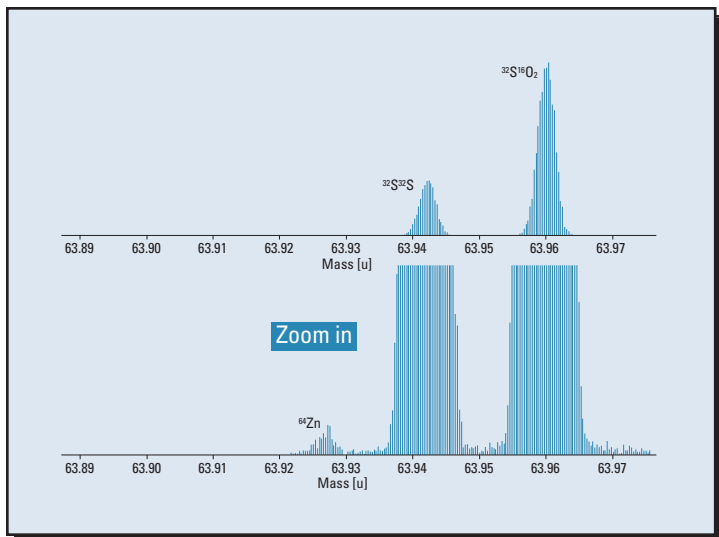

Zinc in H<sub>2</sub>SO<sub>4</sub> (10 % w/w), High Resolution

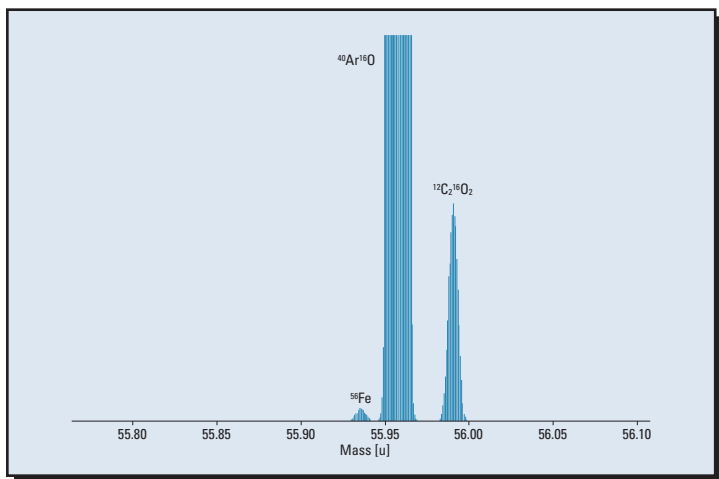

Iron in Liquid Crystal Matrix, Cold Plasma, Medium Resolution

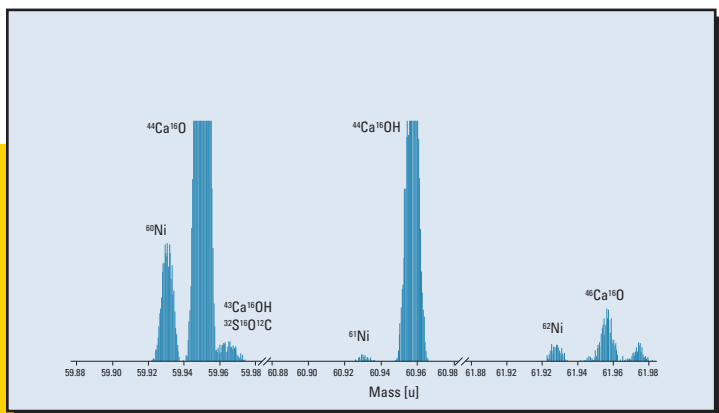

Nickel Isotopes in Groundwater, Medium Resolution

The more complex the sample matrix, the wider the range of interferences that will occur. The main advantage of high mass resolution as a technique to remove spectral interferences is that it is not just limited to a particular type of interference. With high mass resolution, iron at  $m/z$  56 is easily separated in a simple matrix from  $^{40}\text{Ar}^{16}\text{O}$  as well as in more complex matrices from, for example,  $^{40}\text{Ca}^{16}\text{O}$  or  $^{12}\text{C}_2^{16}\text{O}_2$ .

Arsenic at  $m/z$  75 can be determined in HCl, separated from the  $^{40}\text{Ar}^{35}\text{Cl}$  interference, or, in a matrix containing Ca and chloride, from  $^{40}\text{Ca}^{35}\text{Cl}$ .

Matrices such as mineral acids and organic solvents, which form a plethora of spectral interferences, can be easily analyzed using the high resolution mode.

**High resolution results in simple clear spectra and does not create new interferences.**

**Resolution Specification**  
(10 % peak valley definition)

**3 fixed resolutions:**

Low Resolution > 300

Medium Resolution > 4000

High Resolution > 10000

## Principle

The ELEMENT 2 is a double focusing magnetic sector field ICP-MS.

### Plasma and Interface

The argon plasma ion source and sampling interface of the ELEMENT 2/XR are at ground potential<sup>1</sup>. This enables the straightforward coupling of peripherals like HPLC, CE, GC and laser ablation. The interface reduces the initial kinetic energy spread from ~20 to ~5 eV by capacitively decoupling the plasma from the load coil, using a grounded guard electrode. This reduced energy spread increases the ion transmission and delivers superior sensitivities at all resolutions.

The ion transfer optics focus the ions from the plasma interface on the entrance slit of the double focusing analyzer. The ion transfer optics are designed for low background, highest sensitivity and minimum mass bias at maximum stability<sup>2</sup>.

### High Resolution

The ELEMENT 2/XR is able to fully automatically change between three fixed resolutions by switching the positions of the entrance and exit slits in < 1 s. The patented design of the fixed slit mechanism<sup>3</sup> offers maximum stability and reproducibility of resolutions.

<sup>1</sup> Patent issued: US 5552599, GB 2282479

<sup>2</sup> Patent issued: US 5625185

<sup>3</sup> Patent issued: US 5451780, GB 2281438

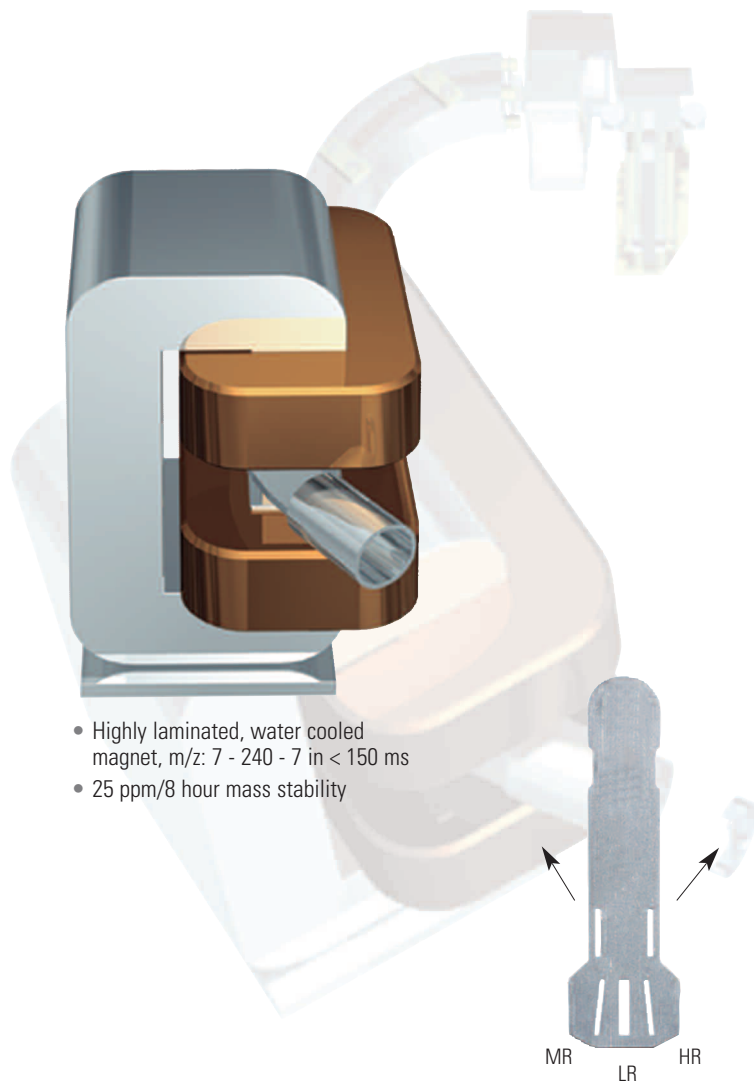

- Highly laminated, water cooled magnet,  $m/z$ : 7 - 240 - 7 in < 150 ms
- 25 ppm/8 hour mass stability

- 3 fixed resolutions:  
R = 300  
R = 4000  
R = 10000



- Ion Transfer Optics  
Guarantees a flat response curve,  
low background and high sensitivity



- Simultaneous measurement in analog and counting modes
- $> 10^9$  linear dynamic range (ELEMENT 2)
- $> 10^{12}$  linear dynamic range (ELEMENT XR)
- $< 0.2$  cps dark noise
- Fully automatic cross calibration



- Interface at ground potential
- Easily changeable cones
- Resistant against chemicals

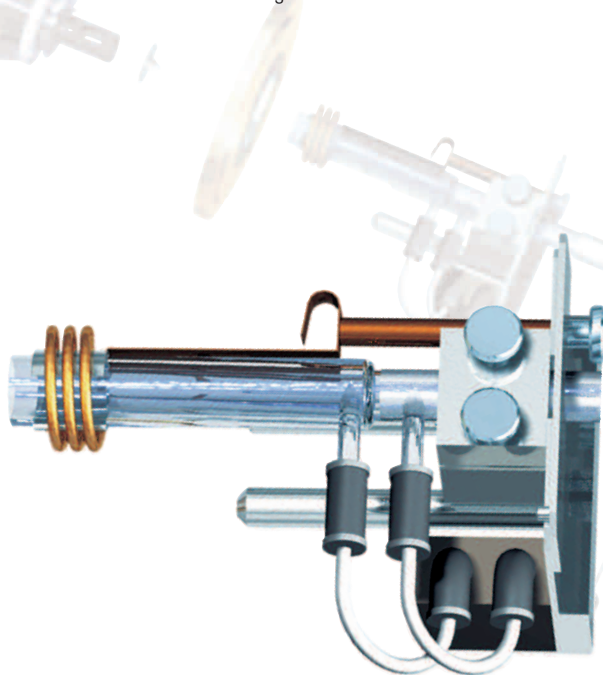

- Torch with Guard Electrode (GE)  
The GE decreases the ion energy spread, thus increasing ion transmission. This and the high acceleration voltage used in a sector field ICP-MS results in increased sensitivity. The GE is also required for Cold Plasma measurements

## Mass Separation

The magnetic field disperses ions according to their mass and energy. The magnet used in the ELEMENT 2/XR is specifically designed for use in ICP-MS applications. It is relatively small (sufficient for the mass range 0 – 260 u), highly laminated and efficiently water-cooled for the highest mass stability. Changing of the magnetic field is controlled by a magnetic field regulator with a new high power stage, which delivers the fastest scan speed ever possible with a magnetic sector field instrument <sup>4</sup>.

After passing through the magnetic field the ions enter the electrostatic analyzer for energy focusing. The combination of the magnetic and electrostatic fields results in the double focusing, high resolution properties of the ELEMENT 2/XR.

## Detection System

The ELEMENT 2 is equipped with a discrete dynode detector system. Rather than having the ion beam directly strike the detector to initiate an electron cascade, the secondary electron multiplier implemented in the ELEMENT 2 uses a conversion dynode at -8 kV, producing a uniform response across the mass range. The detector is linear over nine orders of magnitude – from ppq to ppm concentrations. The quantification of trace and major elements is therefore possible in a single analysis.

## Another step ahead

The detection system of the ELEMENT XR increases the linear dynamic range to  $> 10^{12}$  orders of magnitude by incorporating a single Faraday detector.

<sup>4</sup> Thermo Scientific Technical Note TN30074\_E

# Resolution

## Low Resolution

Low resolution ( $R = 300$ ) is used for the analysis of non-interfered isotopes. In this mode the ELEMENT 2's sensitivity is the highest of all commercially available ICP-MS instruments. Additionally, the flat top peak shape is an advantage for high precision isotope ratio measurements.

## Medium Resolution

Medium resolution ( $R = 4000$ ) guarantees interference-free analysis for most elements in the majority of sample matrices. For example, transition elements are routinely measured in medium resolution due to the formation of many interfering polyatomic species in the mass range 24 – 70 u.

## High Resolution

High resolution ( $R = 10000$ ) is used for the analysis of elements in the most challenging sample matrices. For example, high resolution is used to separate As and Se from argon dimer interferences and argon chloride interferences in chlorine matrices, heavy rare earth elements from light rare earth element oxides in geological matrices, platinum group elements from argon-transition metal molecular species, and/or the oxides of Hf, Ta and W.

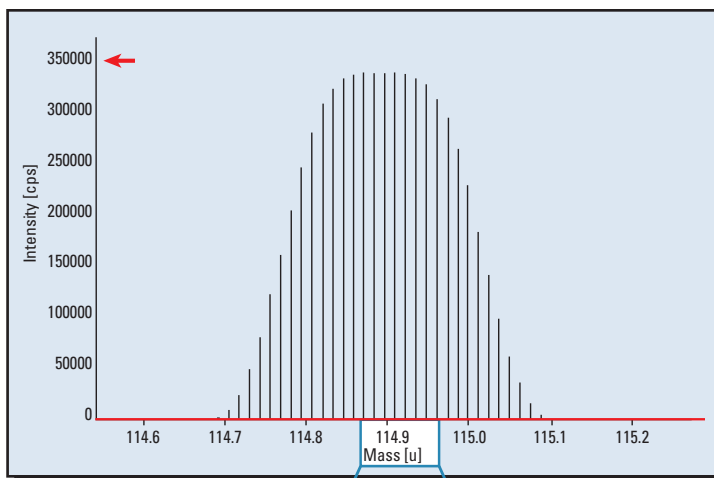

100 ng/L  $^{115}\text{In}$ , Low Resolution

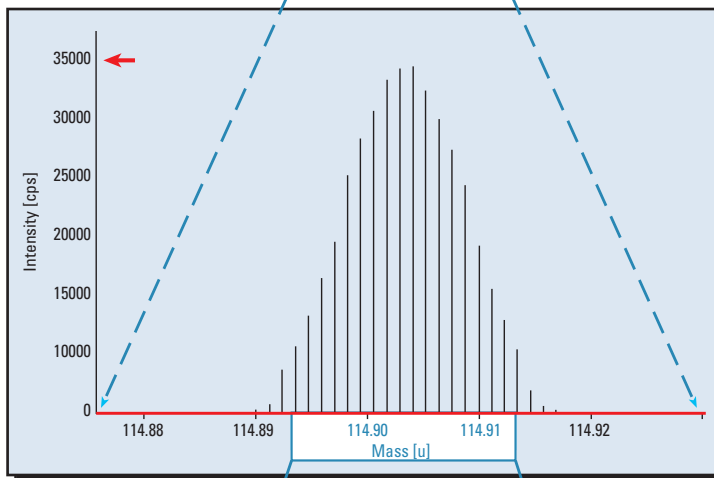

100 ng/L  $^{115}\text{In}$ , Medium Resolution

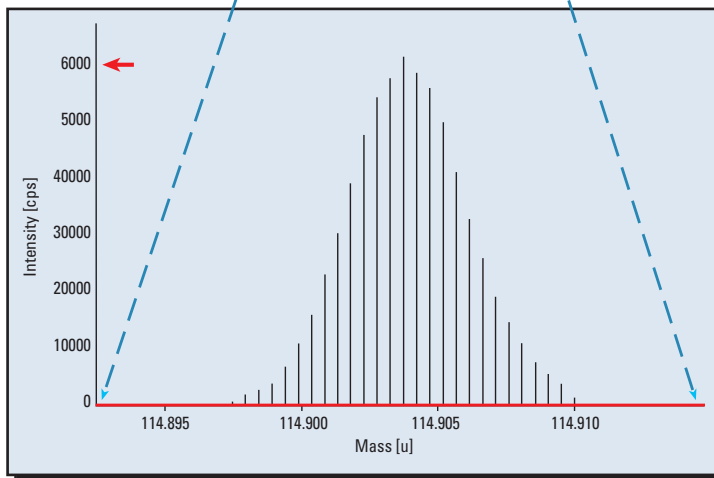

100 ng/L  $^{115}\text{In}$ , High Resolution



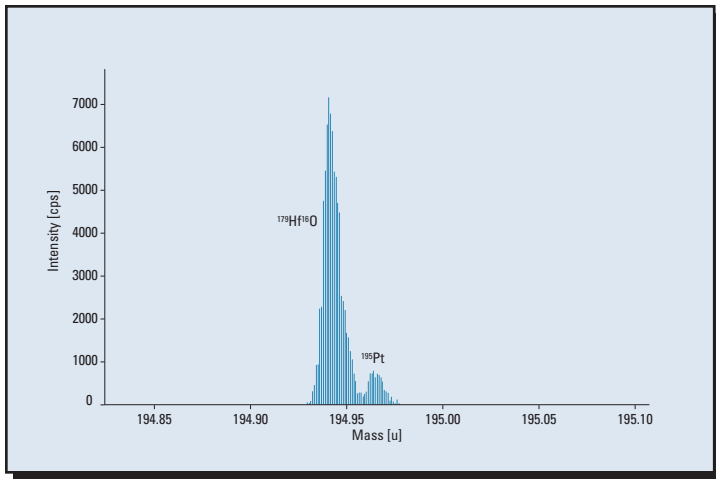

100 µg/L Hafnium, 100 ng/L Platinum, High Resolution

Since the change in mass resolution is achieved by changing the width of the entrance and exit slits of the mass spectrometer, the instrumental sensitivity of a high resolution ICP-MS is dependent on the resolution mode used. Therefore, the ELEMENT 2/XR with three fixed resolutions has three sensitivities: the wider the slit, the higher the sensitivity.

**Fixed sensitivity ratio between resolutions: independent of mass and matrix.**

**Even in high resolution mode, the intrinsic sensitivity of the ELEMENT 2/XR provides sub ppt detection limits.**

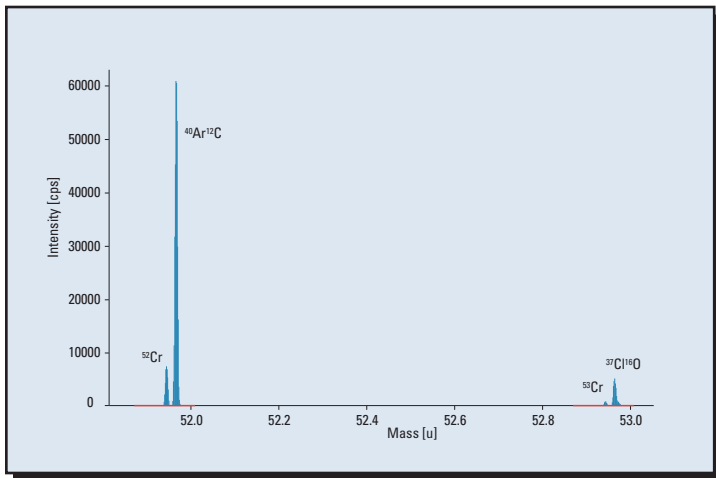

Chromium in Blood, Medium Resolution

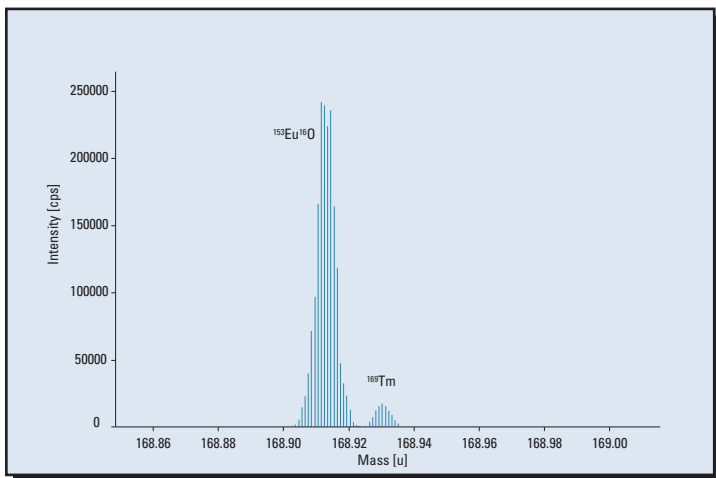

Thulium in Europium Matrix, High Resolution

### Sensitivity Specification

Low Resolution (R = 300)

$^{115}\text{In} > 1 \times 10^6$  cps/ppb

Medium Resolution (R = 4000)

$^{115}\text{In} > 1 \times 10^5$  cps/ppb

High Resolution (R = 10000)

$^{115}\text{In} > 1.5 \times 10^4$  cps/ppb

Background in all 3 resolutions < 0.2 cps

# Sensitivity and Stability

## Sensitivity and Low Background

It is obvious that the highest instrumental sensitivity is essential to achieve the lowest detection limits. However, it is the signal to noise ratio that dictates the detection limit. The ELEMENT 2/XR guarantees an off-peak background of < 0.2 cps for all three resolutions. Detection limits in the fg/L range are possible.

## Detection Limits in Complex Matrices

Even in cases where the lowest detection limits are not the goal, the exceptionally high sensitivity of the ELEMENT 2/XR offers an important advantage. With the higher sensitivity, higher dilution factors for complex matrices can be used without sacrificing detection limits.

## Sensitivity and 'Dilute and Shoot'

The requirement for matrix separation for samples such as seawater, mineral acids or organic solvents is replaced by a simple dilution. Using this 'dilute and shoot' approach, the matrix load on the sample introduction system, plasma and interface is reduced. This is also particularly important for the analysis of nuclear sample matrices where the minimization of waste is of paramount importance.

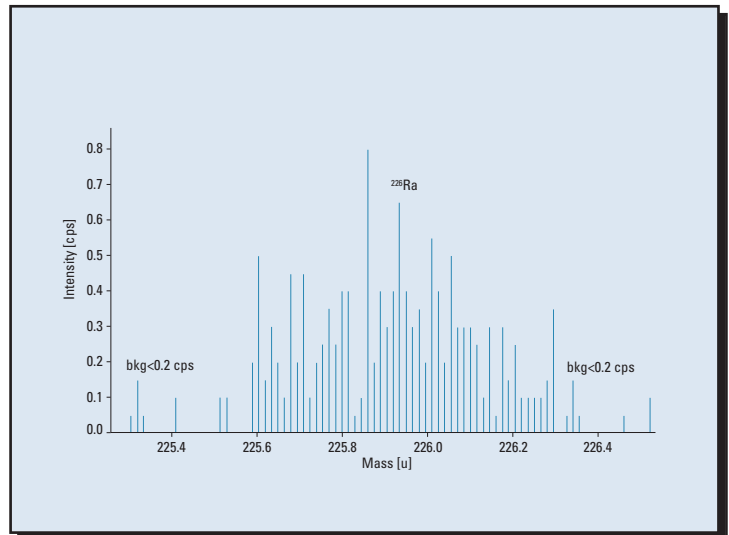

Mineral Water, undiluted (5 % HNO<sub>3</sub>), ~200 fg/L Radium, Low Resolution

	<i>Resolution</i>	<i>LoD [ng/L] in solution</i>
<sup>23</sup> Na	Low	1.3
<sup>90</sup> Zr	Low	0.06
<sup>107</sup> Ag	Low	0.03
<sup>151</sup> Eu	Low	0.04
<sup>47</sup> Ti	Medium	0.3
<sup>52</sup> Cr	Medium	0.3
<sup>63</sup> Cu	Medium	0.6
<sup>66</sup> Zn	Medium	1.5
<sup>79</sup> Br	Medium	5.0
<sup>75</sup> As	High	2.0
<sup>155</sup> Gd	High	0.2

Detection Limits in 50 mg/L Uranium

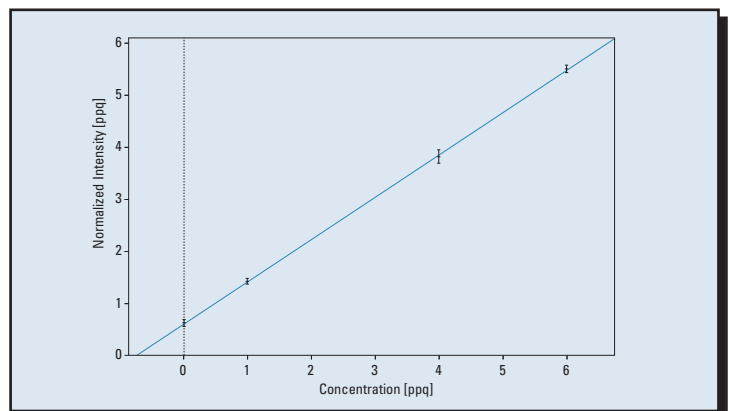

<sup>226</sup>Ra, External Calibration, 1, 4, 6 pg/L, R<sup>2</sup> = 1.000

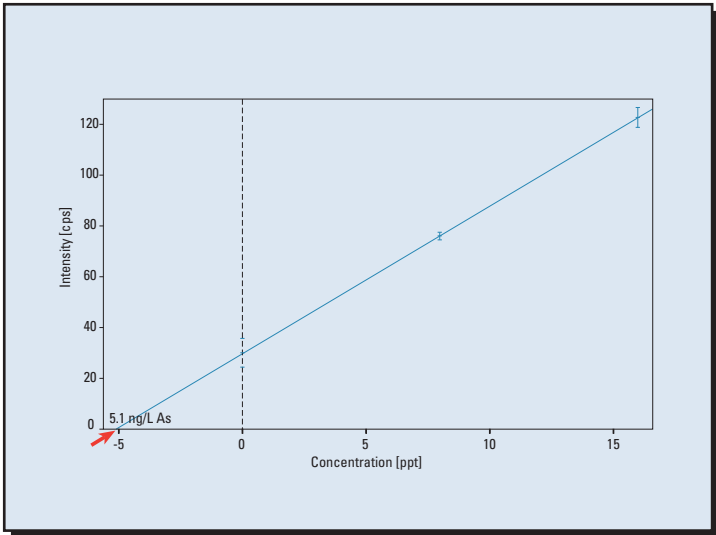

Standard Addition Analysis of Arsenic in HCl (10 % v/v)

### Signal Stability and Detection Limits

Sector field ICP-MS offers superior ion transmission stability due to the high acceleration voltage (-8 kV) and excellent focusing properties.

In combination with the high sensitivity, low background, interference-free measurements and an advanced sample introduction system, the ELEMENT 2/XR delivers the lowest detection limits – independent of the sample matrix. The resulting low detection limits combined with highest stability at single digit ppt level enable quantification at the lowest concentrations.

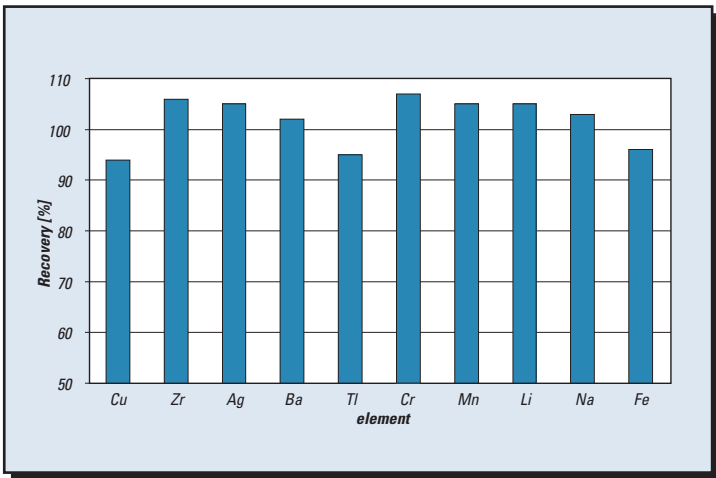

1 ng/L Spike Recovery UPW

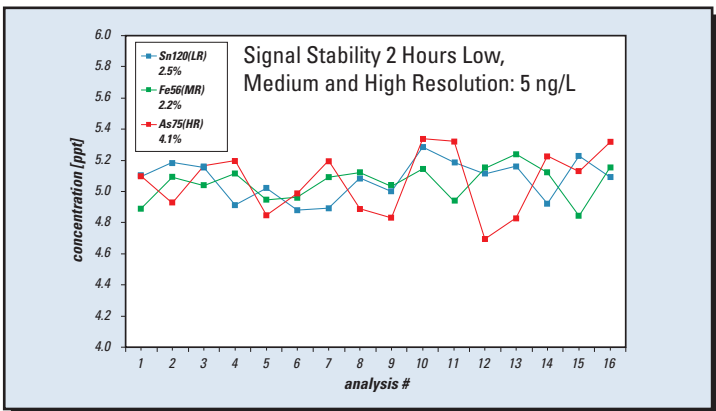

### Stability Specifications

- < 1 % RSD in 10 minutes
- < 2 % RSD in 1 hour

## Mass Stability

The mature design of the ELEMENT 2 delivers the fastest scan speed ever for a magnetic sector field ICP-MS. With the ELEMENT 2 a jump from 7 to 240 to 7 is realized in < 150 ms.

### Scanning

Routine scanning is performed by a combination of magnetic and electric jumps.

The ELEMENT 2/XR has the unique capability to scan +30 % from the magnet mass by decreasing the acceleration voltage. The magnetic field is kept constant while the acceleration voltage is varied. This ingenious combination of scan techniques delivers the fastest scanning ever realized by a sector field ICP-MS.

### Mass Stability

The ELEMENT 2/XR guarantees the highest mass stability of any ICP-MS. This enables fast peak top jumping analyses rather than scanning across the whole peak, thus significantly decreasing analysis times. A combination of mature hardware and intelligent software guarantees mass stability in high resolution, which makes mass calibration a rare event.

The synthesis of these characteristics combined with high sensitivity, allowing short integration times, makes the ELEMENT 2/XR the fastest sector field ICP-MS ever.

***The scan speed of the ELEMENT 2 in combination with the high sensitivity opens the dimension of its use as a detector for fast transient signals.***

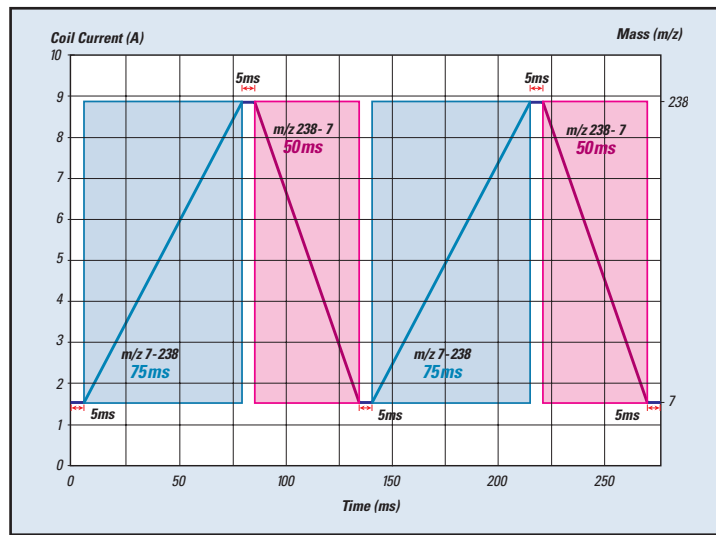

Timing for a Full Magnet Cycle

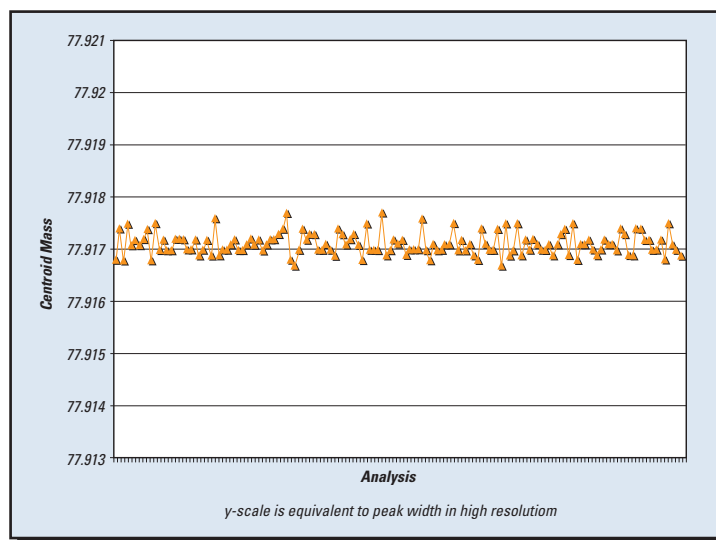

12-Hour Mass Stability for <sup>78</sup>Se in high resolution

### Specifications

Mass stability: 25 ppm / 8 hours

Magnetic scan speed: m/z 7 to 240 to 7 < 150 ms

# Ion Detection System

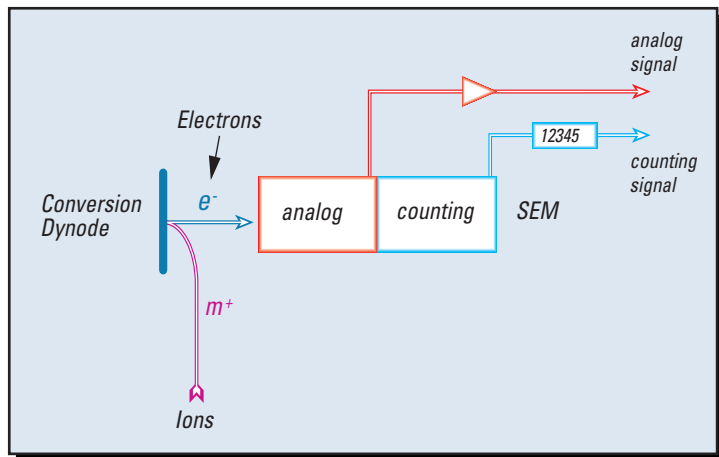

ELEMENT 2 Ion Detection System

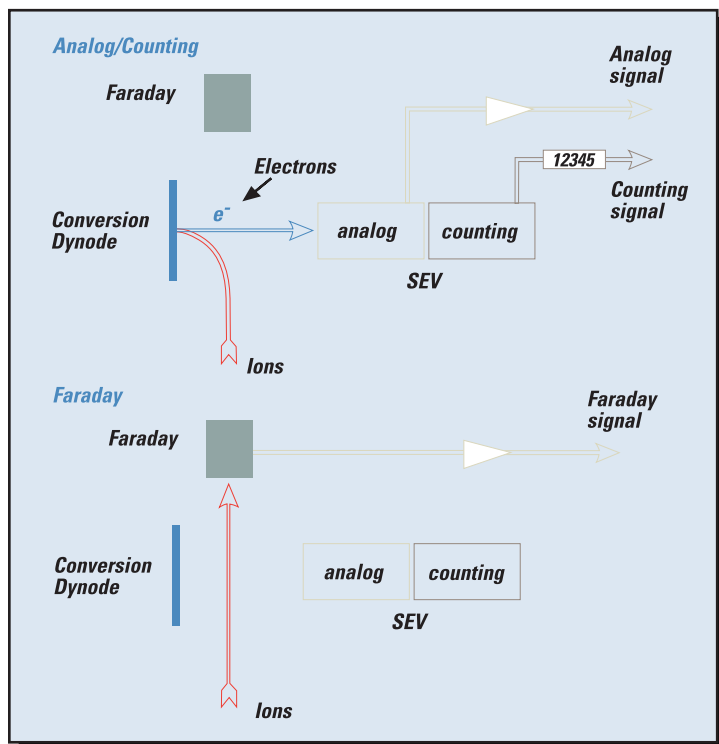

ELEMENT XR Ion Detection System

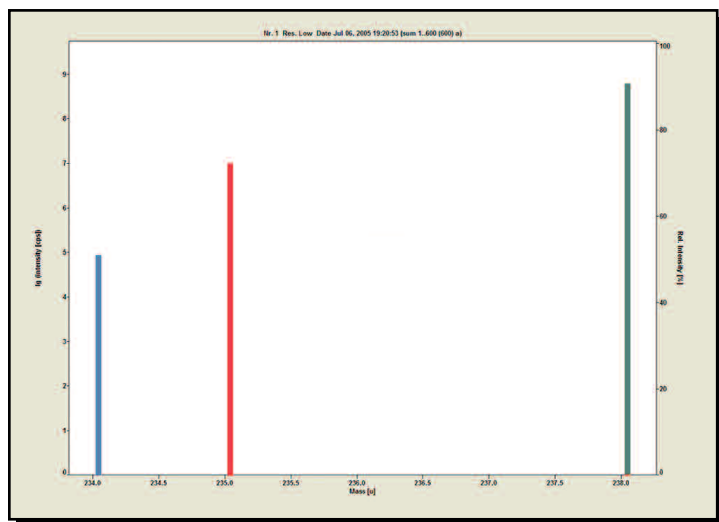

The goal of real life analysis is the simultaneous determination of major and trace elements.

The ELEMENT 2 is equipped with a discrete dynode detection system that enables the quantification of both trace and major elements in a single analysis across a dynamic range of  $10^9$ .

The ELEMENT 2 detector system incorporates a conversion dynode at -8 kV. The high acceleration to -8 kV results in a mass independent detector response, enabling fully automatic cross calibration between the counting and analog modes.

**No user interaction is necessary.**

The automatic cross calibration ensures a constantly updated detector response at all times – ready for the unexpected sample!

Additionally the detector enables the measurement of large isotope ratios. With the minor isotope in counting mode and the abundant isotope in analog mode the highest precision and accuracy can be obtained.

## Another step ahead

The most recent high resolution ICP-MS, the Thermo Scientific ELEMENT XR, opens another dimension of linearity in ICP-MS. Incorporating a single Faraday detector in addition to the discrete dynode detector offers > 12 orders of magnitude linear dynamic range. Herewith the dream of analyzing ultra-trace elements and matrix elements within the same analysis becomes true!

Extremely short integration times of < 1 ms in analog and Faraday mode, and 0.1 ms in counting mode in combination with a switching time of 1 ms between analog and faraday mode, makes the ELEMENT XR the perfect tool for transient signals such as those from laser ablation.

## Specifications

Dynamic Range >  $10^9$  with automatic gain calibration (ELEMENT 2)

Dynamic Range >  $10^{12}$  with automatic gain calibration (ELEMENT XR)

## The Software Suite

### The ELEMENT 2/XR Software

The ELEMENT 2/XR software controls and monitors all instrument functions for ICP-MS analysis. This includes data acquisition and auto-tuning of the ELEMENT 2/XR.

The software also provides the full range of quantification procedures required in elemental analysis (qualitative, quantitative, semi-quantitative, isotope dilution) as well as isotope ratio and time resolved analysis modes.

### Controlling and Tuning

- Autotuning of all parameters, including ICP parameters, torch position, lenses and multiplier voltage
- Fully automated and configurable plasma start and stop sequence
- Easy autosampler setup using a graphical display of the autosampler

### Setup of Methods

- Intuitive and easy selection of target isotopes in periodic table or spreadsheet display modes
- Automatic, customizable isobaric interference correction
- Spreadsheet style 'click-and-drag' cell fill down

### Creating and Running Sequences

- Intuitive and easy creation of sample analysis sequences in graphical or spreadsheet display modes
- Integrated powerful QA/QC package that meets internationally regulated requirements including US EPA 200.8 and 6020. The flexible editor included can be used to define specific QA/QC criteria in any laboratory.

### Displaying Results and Creation of Reports

- Real time display of spectra, calibration curves, fully quantitative results and time resolved analyses
- On-line export of time resolved data in several formats (ASCII, GRAMS, Spectacle, GLITTER, ANDI and Xcalibur® for further analysis in third party programs)

- Remote Control & Diagnostic
- Setting & Read-Back of All Instrument Parameters

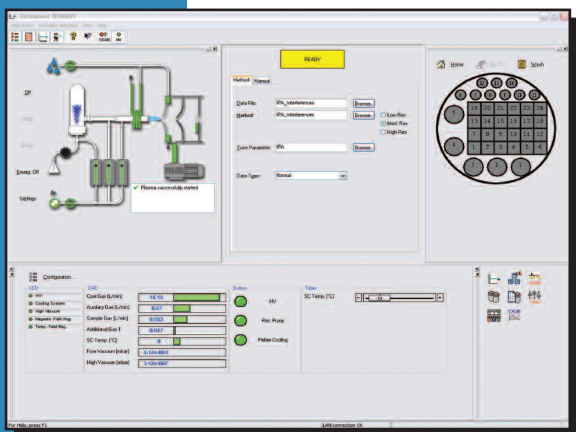
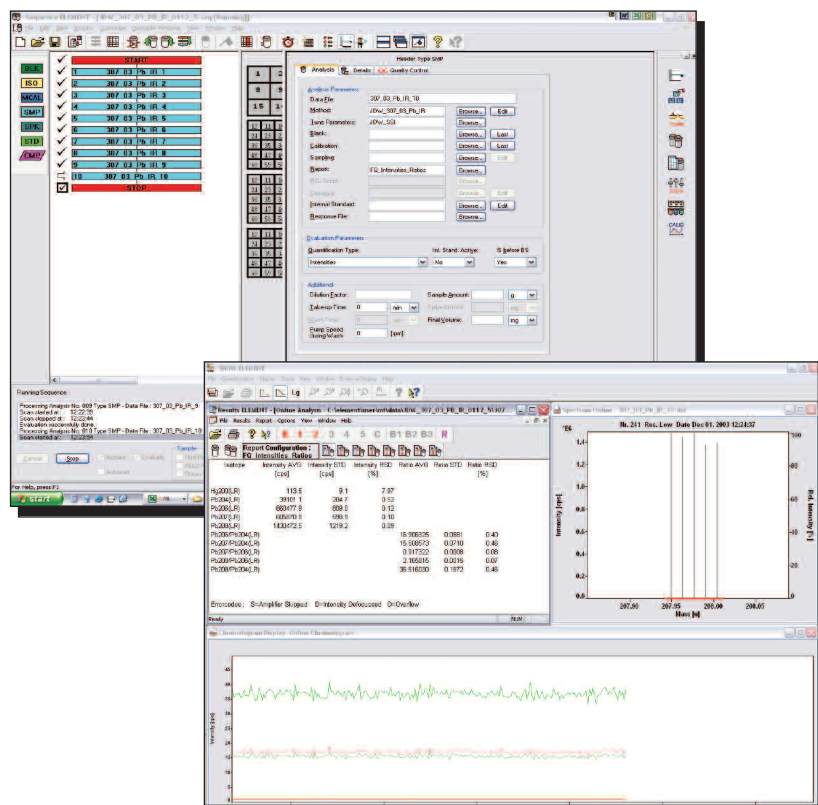

Instrument Startup and Autosampler Control

The ELEMENT 2/XR software is a state-of-the-art, simple to use software suite taking advantage of the reliability and stability of Windows™ XP Professional. The software package is optimized for the needs of the routine analyst, providing stability and ease of use for basic operation of the ELEMENT 2/XR, and yet retains the flexibility for advanced operation.

Due to the use of the Windows™ XP Professional operating system and standardized programming, the data system computer can be easily connected to a network, enabling data transfer and allowing remote control of the ELEMENT 2/XR.

# Product Specification

## Specifications and Installation Requirements

Sensitivity (Concentric Nebulizer)	> 1 x 10 <sup>9</sup> counts per second (cps)/ppm In	
Detection Power	< 1 ppq for non-interfered nuclides	
Dark Noise	< 0.2 cps	
Dynamic Range	> 10 <sup>9</sup> linear with automatic gain calibration (ELEMENT 2) > 10 <sup>12</sup> linear with automatic gain calibration (ELEMENT XR)	
Mass Resolution	300, 4000, 10,000 (10 % valley, equivalent to 5 % height); 600, 8000, 20,000 (FWHM)	
Signal Stability	< 1 % RSD over 10 minutes < 2 % RSD over 1 hour	
Scan Speed (magnetic)	m/z 7 to 240 to 7 < 150 ms	
Scan Speed (electric)	1 ms/jump, independent of mass range	
Oxide and Doubly Charged Ions	ratio	measured
	BaO <sup>+</sup> /Ba <sup>+</sup>	< 0.002
	Ba <sup>2+</sup> /Ba <sup>+</sup>	< 0.03
Power	3-phase, 230/400 V ±10 %, 50/60 Hz fused 32 A per phase Power consumption: ~9 kVA	
Environment	Temperature 18 – 24 °C (64 – 75 °F) Humidity 50 – 60 %, noncondensing, non-corrosive	
Cooling Water	~ 200 l/h Temperature 10 – 20 °C 4 – 6 bar (43 – 65 psi)	
Argon	Purity 99.996 min. 18 L/min Regulated pressure 8 –10 bar (116 –145 psi) Uninterrupted argon supply recommended	
Plasma Exhaust	1 x 6 cm Ø; 90 m <sup>3</sup> /h (Argon + suspended sample)	
Electronics Exhaust	2 x 15 cm Ø; 800 m <sup>3</sup> /h	

## ELEMENT 2 and ELEMENT XR: Footprint and Dimensions (all dimensions in cm)

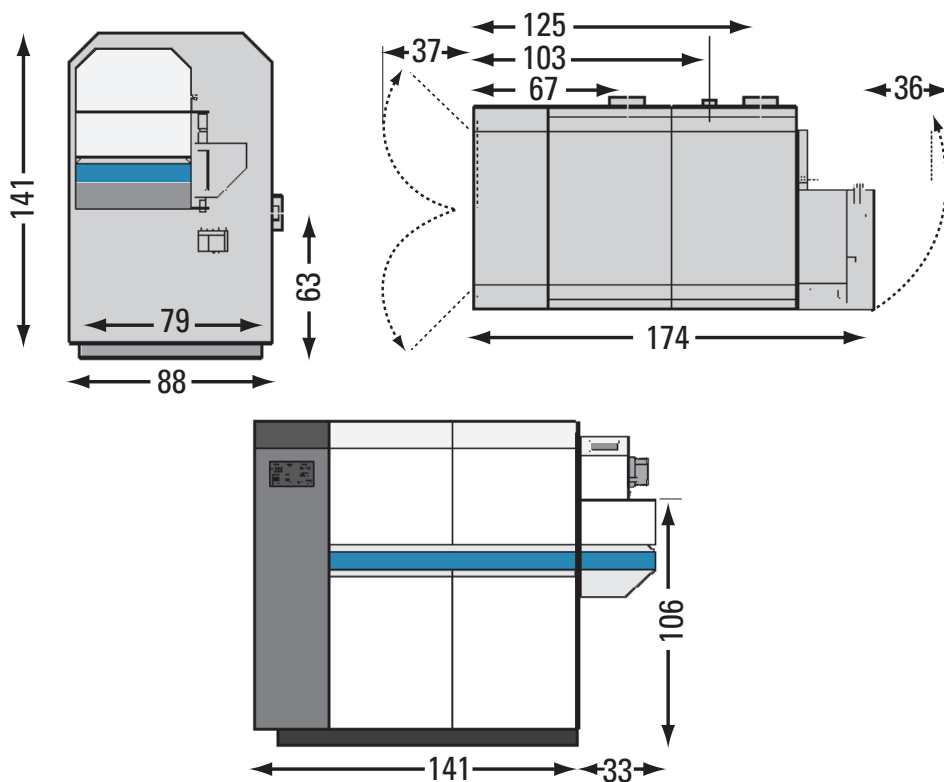

# Plasma Capabilities from Thermo Fisher Scientific

The use of an Inductively Coupled Plasma source (ICP) is the accepted and most powerful technique for the analysis and quantification of trace elements in both solid and liquid samples. Its applications range from routine environmental analyses to the materials industry, geological applications to clinical research and from the food industry to the semiconductor industry.

Thermo Fisher Scientific is the only instrument manufacturer to offer the full range of Inductively Coupled Plasma Spectrometers (ICP, Quadrupole and Sector Field ICP-MS) to satisfy every aspect of plasma spectrometry from routine to highly demanding research applications.

Develop your lab from the easy-to-use Thermo Scientific iCAP ICP to the high performance Thermo Scientific XSERIES 2 Quadrupole ICP-MS and up to the ultra-sophisticated ELEMENT 2 and NEPTUNE Sector Field ICP-MS instruments. Each instrument combines leading-edge technology, fit for purpose and affordability with a tradition of quality, longevity, accuracy and ease of use.

For direct analysis of conductive materials down to the parts per billion (ppb), Thermo Fisher Scientific also offers Glow Discharge technology: the Thermo Scientific ELEMENT GD.

## Thermo Scientific iCAP ICP

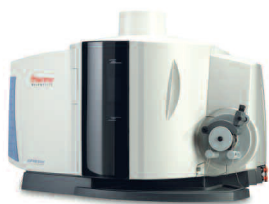

## Thermo Scientific XSERIES 2 ICP-MS



## Thermo Scientific ELEMENT 2/XR Sector Field ICP-MS or ELEMENT GD Glow Discharge ICP-MS



## Thermo Scientific NEPTUNE Multicollector ICP-MS



In addition to these offices, Thermo Fisher Scientific maintains a network of representative organizations throughout the world.

- Africa**  
+43 1 333 5034 127 \* analyze.emea@thermo.com
- Australia**  
+61 2 8844 9500 \* analyze.au@thermo.com
- Austria**  
+43 1 333 50340 \* analyze.at@thermo.com
- Belgium**  
+32 2 482 30 30 \* analyze.be@thermo.com
- Canada**  
+1 800 530 8447 \* analyze.ca@thermo.com
- China**  
+86 10 8419 3588 \* analyze.cn@thermo.com
- Denmark**  
+45 70 23 62 60 \* analyze.dk@thermo.com
- Europe - Other**  
+43 1 333 5034 127 \* analyze.emea@thermo.com
- France**  
+33 1 60 92 48 00 \* analyze.fr@thermo.com
- Germany**  
+49 6103 408 1014 \* analyze.de@thermo.com
- India**  
+91 22 6742 9434 \* analyze.in@thermo.com
- Italy**  
+39 02 950 591 \* analyze.it@thermo.com
- Japan**  
+81 45 453 9100 \* analyze.jp@thermo.com
- Latin America**  
+1 608 276 5659 \* analyze.la@thermo.com
- Middle East**  
+43 1 333 5034 127 \* analyze.emea@thermo.com
- Netherlands**  
+31 76 579 55 55 \* analyze.nl@thermo.com
- South Africa**  
+27 11 570 1840 \* analyze.sa@thermo.com
- Spain**  
+34 914 845 965 \* analyze.es@thermo.com
- Sweden / Norway / Finland**  
+46 8 556 468 00 \* analyze.se@thermo.com
- Switzerland**  
+41 61 48784 00 \* analyze.ch@thermo.com
- UK**  
+44 1442 233555 \* analyze.uk@thermo.com
- USA**  
+1 800 532 4752 \* analyze.us@thermo.com

[www.thermo.com](http://www.thermo.com)



Thermo Fisher Scientific (Bremen) GmbH  
is certified DIN EN ISO 9001:2000

©2008 Thermo Fisher Scientific Inc. All rights reserved.  
Windows is a registered trademark of Microsoft Corporation in the United States and possibly other countries. All other trademarks are the property of Thermo Fisher Scientific Inc. and its subsidiaries.

Specifications, terms and pricing are subject to change.  
Not all products are available in all countries. Please consult your local sales representative for details.

BR30027\_E 11/08C

**Thermo**  
SCIENTIFIC